

Identifying Solid Figures

Name each figure.

1)



2)

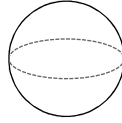

3)

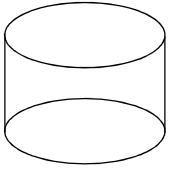

4)

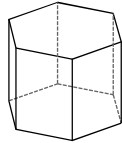

5)

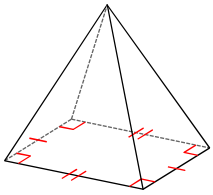

6)



7)

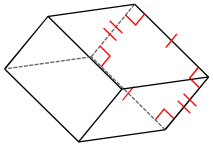

8)

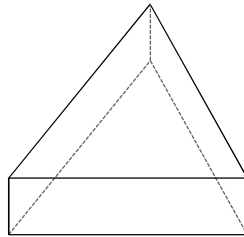

9)

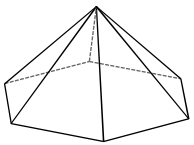

10)

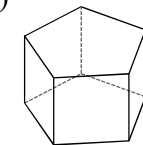

11)

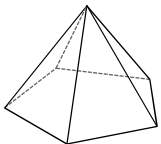

12)

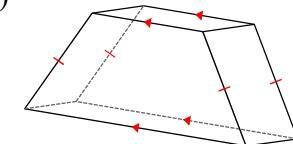

Identify each solid given its net.

13)

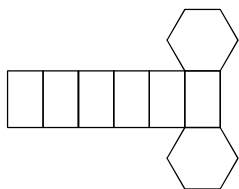

14)

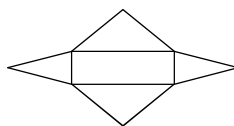

15)

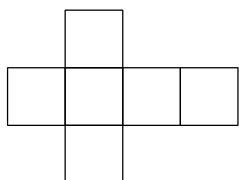

16)

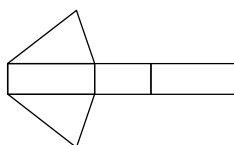

17)

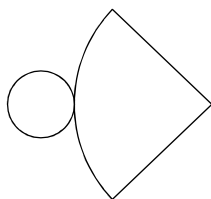

18)

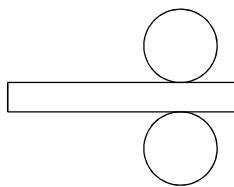

Sketch that solid that can be created from each net.

19)

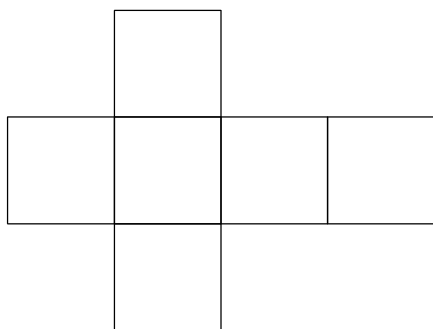

20)

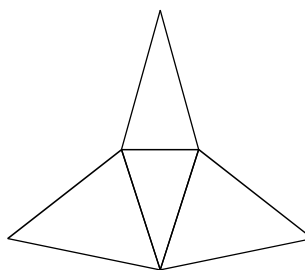

21)

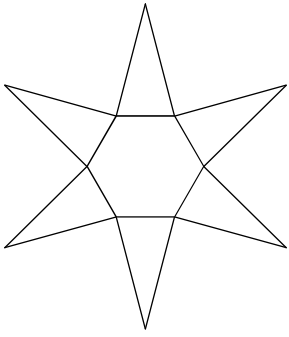

22)

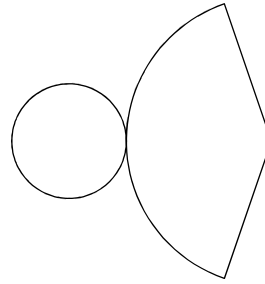

23)

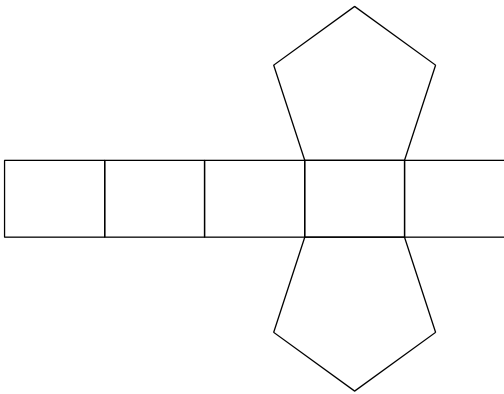

24)

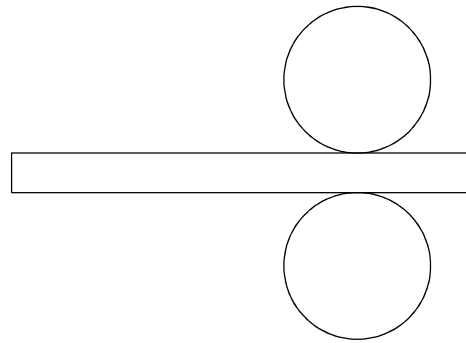

Sketch the net of each solid.

25)

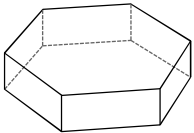

26)



27)

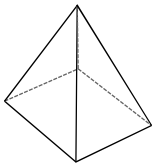

28)

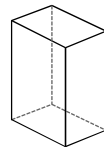

29)

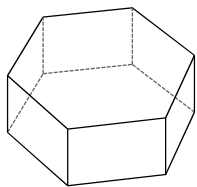

30)

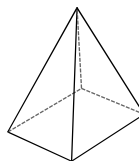

Copy the measurements given onto the net of each solid.

31)

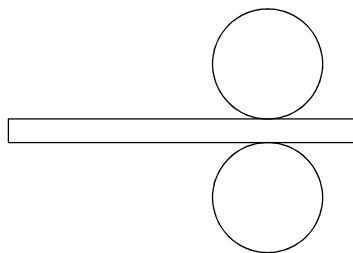
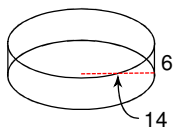

32)

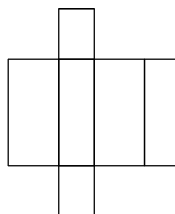
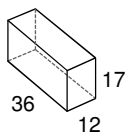

Volume of Prisms and Cylinders

Find the volume of each figure. Round your answers to the nearest hundredth, if necessary.

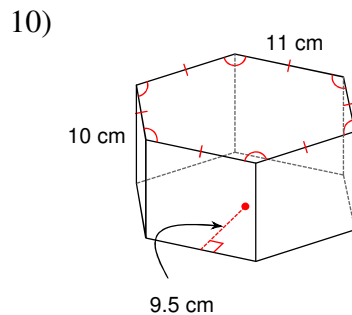
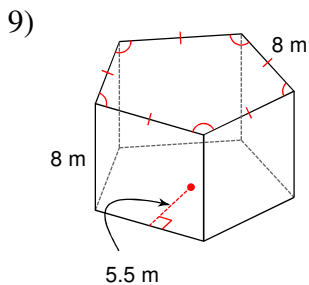
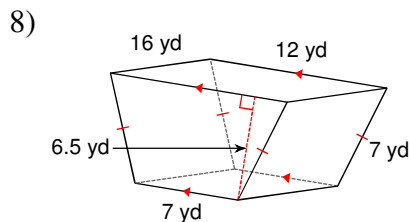
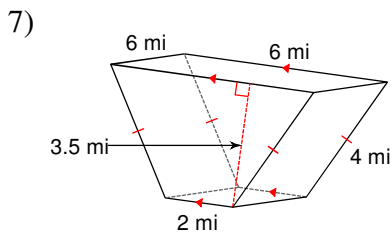
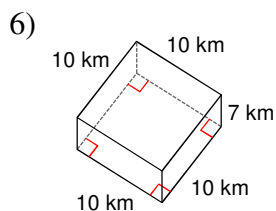
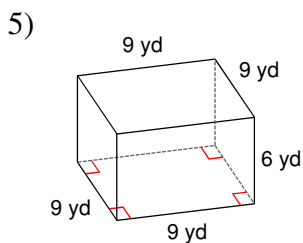
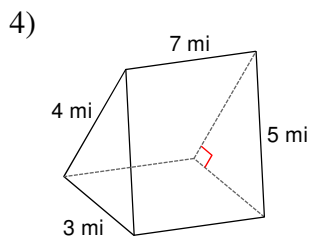
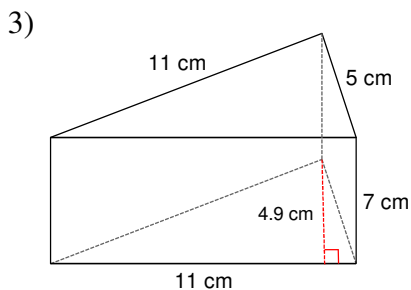
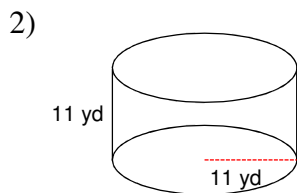
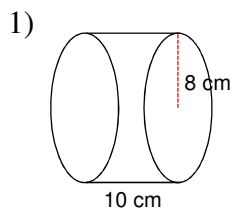

11)

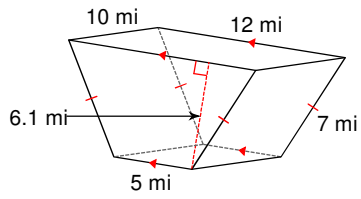

12)

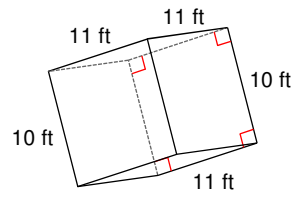

13) A trapezoidal prism of height 10 mi. The parallel sides of the base have lengths 10 mi and 4 mi. The other sides of the base are each 6 mi. The trapezoid's altitude measures 5.2 mi.

14) A rectangular prism measuring 4 in and 6 in along the base and 6 in tall.

Surface Area of Prisms and Cylinders

Find the surface area of each figure. Round your answers to the nearest hundredth, if necessary.

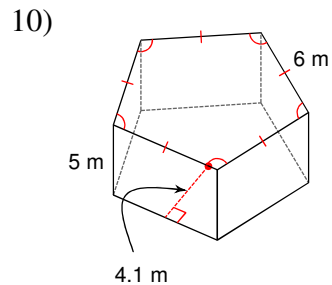
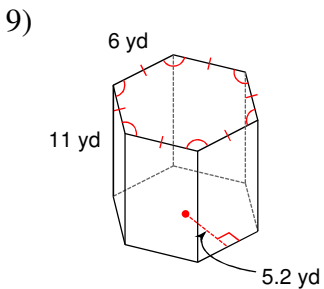
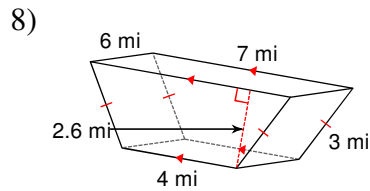
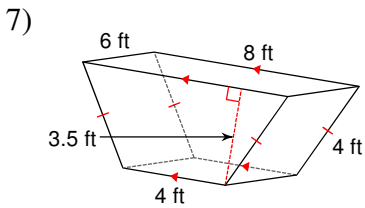
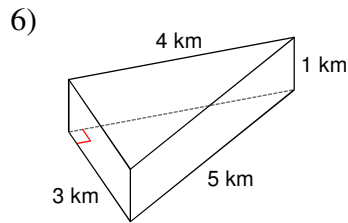
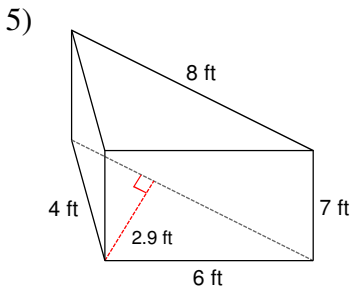
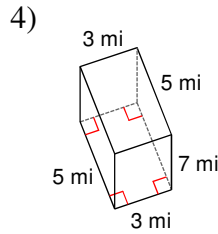
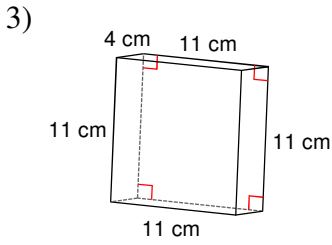
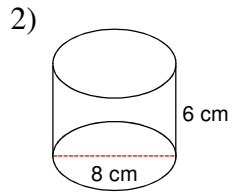
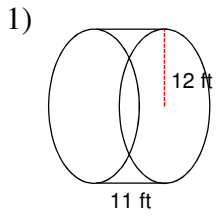

11)

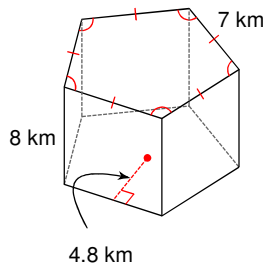

12)

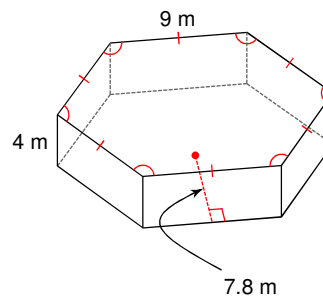

13) A cylinder with a diameter of 4 km and a height of 11 km.

14) A prism 5 mi tall with a right triangle for a base with side lengths 6 mi, 8 mi, and 10 mi.

Volume of Pyramids and Cones

Find the volume of each figure. Round your answers to the nearest hundredth, if necessary.

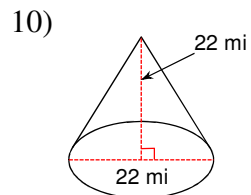
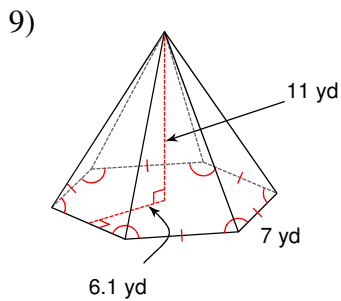
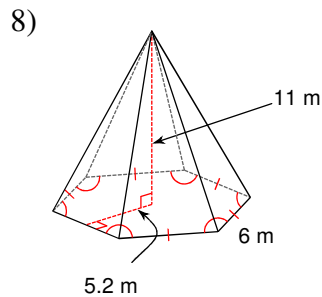
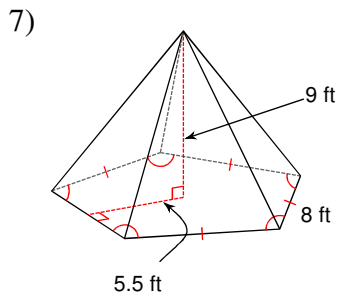
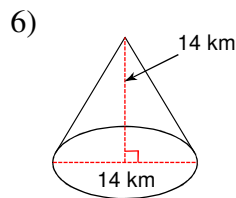
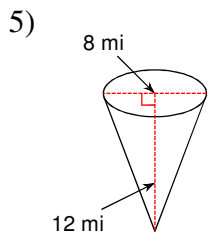
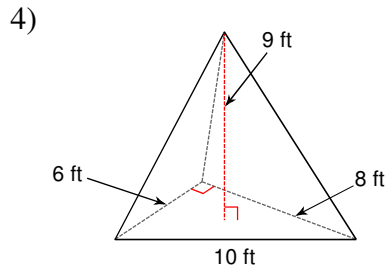
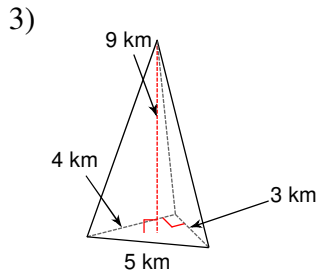
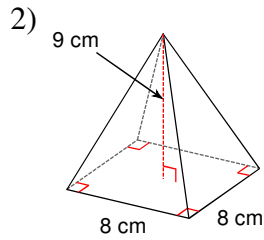
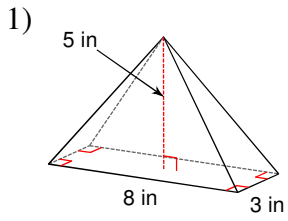

11)

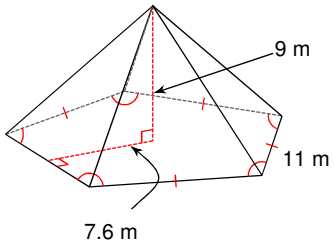

12)

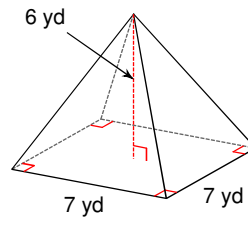

13) A pentagonal pyramid 12 mi tall with a regular base measuring 6 mi on each side and an apothem of length 4.1 mi.

14) A square pyramid measuring 8 ft along each edge of the base with a height of 12 ft.

Surface Area of Pyramids and Cones

Find the surface area of each figure. Round your answers to the nearest hundredth, if necessary.

1)

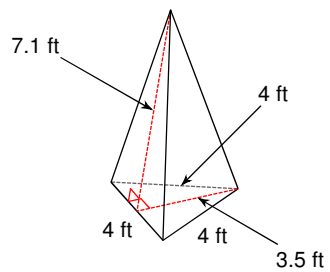

2)

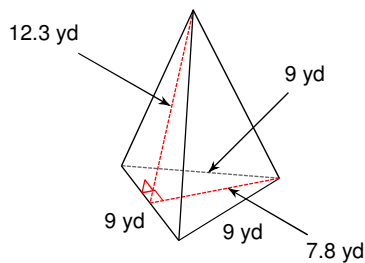

3)

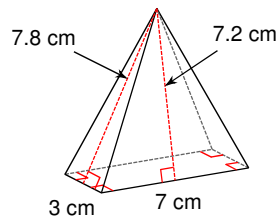

4)

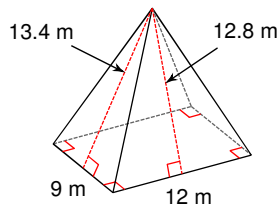

5)

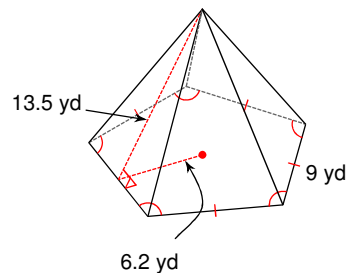

6)

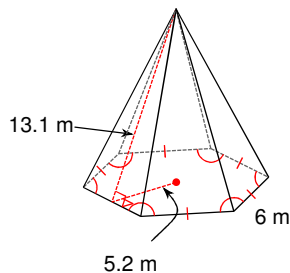

7)

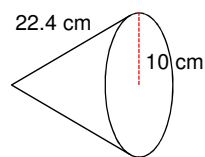

8)

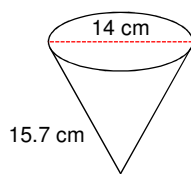

9)

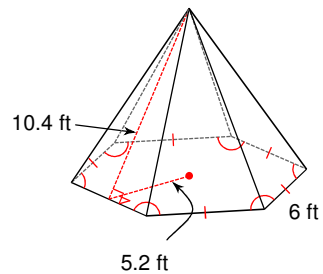

10)

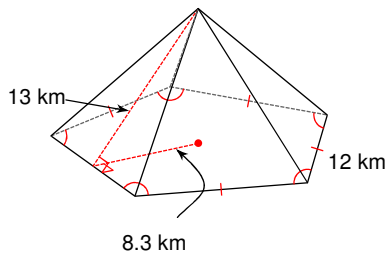

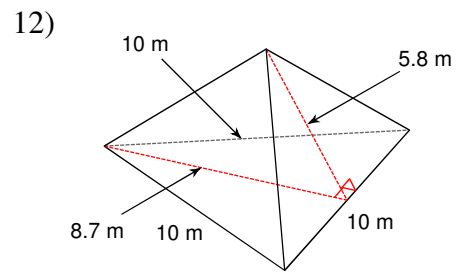
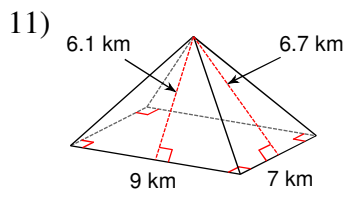

13) A pyramid with slant height 3.1 in whose triangular base measures 2 in on each side. Each altitude of the base measures 1.7 in.

14) A hexagonal pyramid with a slant height of 13.4 mi and a regular base measuring 7 mi on each side with an apothem of 6.1 mi.

Volume and Surface Area of Spheres

Find the volume of each figure. Round your answers to the nearest hundredth, if necessary.

1)

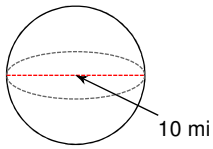

2)

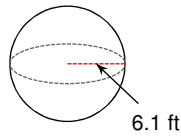

3)

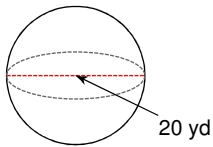

4)

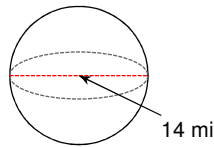

5)

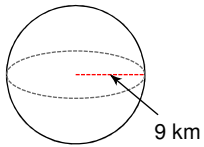

6)

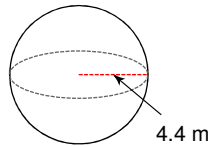

7) A sphere with a diameter of 4.6 in.

8) A sphere with a diameter of 20 cm.

Find the surface area of each figure. Round your answers to the nearest hundredth, if necessary.

9)

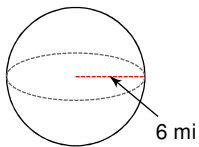

10)

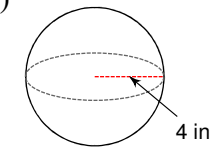

11)

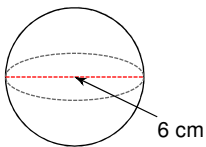

12)

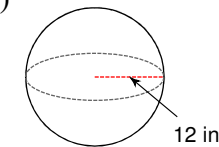

13)

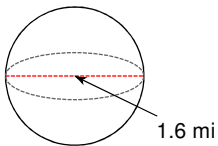

14)

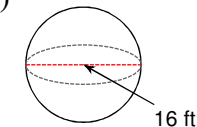

15) A sphere with a radius of 3 m.

16) A sphere with a radius of 2.6 cm.